

# ROLLER THRUST BEARINGS

## METRIC SIZES

Inside Diameters  
30mm to 90mm

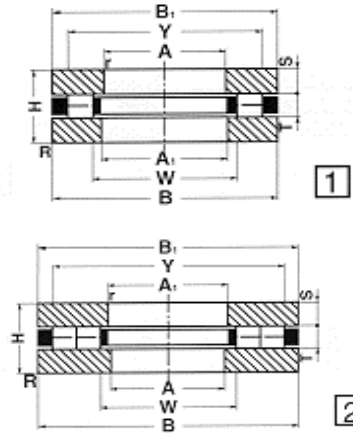

Part Number		A	B	H	T	S	R	r	A1	B1	W	Y	C	Co	RPM	Type
		mm	mm	mm	mm	mm	mm	mm	mm	mm	mm	mm	mm	KN		
M3.0006	81106	30	47	11	5	3	1	1	32	47	31	46	24.5	31	7100	1
M3.0106	81206	30	52	16	7.5	4.5	1	1	32	52	31	50	48	56	6700	1
M3.0206	89306	30	60	18	5.5	6.25	1.5	1.5	32	60	33	59	72	104	6200	2
M3.0007	81107	35	52	12	5	3.5	1	1	37	52	36	51	27	37	5100	1
M3.0107	81207	35	62	18	7.5	5.25	1.5	1.5	37	62	36	59	58	68	4800	1
M3.0207	89307	35	68	20	6	7	1.5	1.5	37	68	36	67	87	124	4500	2
M3.0008	81108	40	60	13	6	3.5	1	1	42	60	42	58	38	52	5000	1
M3.0108	81208	40	68	19	9	5	1.5	1.5	42	68	42	66	78	93	4700	1
M3.0208	89308	40	78	22	7	7.5	1.5	1.5	42	78	43	77	114	178	4400	2
M3.0009	81109	45	65	14	6	4	1	1	47	65	47	63	40	59	4800	1
M3.0109	81209	45	73	20	9	5.5	1.5	1.5	47	73	47	70	84	110	4500	1
M3.0209	89309	45	85	24	7.5	8.25	1.5	1.5	47	85	48	83	116	208	4200	2
M3.0010	81110	50	70	14	6	4	1	1	52	70	52	68	42.5	64	4300	1
M3.0110	81210	50	78	22	9	6.5	1.5	1.5	52	78	53	78	86	117	4000	1
M3.0210	89310	50	95	27	8	9.5	2	2	52	95	53	92	124	220	3700	2
M3.0011	81111	55	78	16	6	5	1	1	57	78	57	76	50	72	3600	1
M3.0111	81211	55	90	25	11	7	1.5	1.5	57	90	57	85	115	168	3300	1
M3.0211	89311	55	105	30	9	10.5	2	2	57	105	57	103	170	306	3100	2
M3.0012	81112	60	85	17	7.5	4.75	1.5	1.5	62	85	62	82	72	110	3000	1
M3.0112	81212	60	95	26	11	7.5	1.5	1.5	62	95	62	92	127	185	2800	1
M3.0212	89312	60	110	30	9	10.5	1.5	1.5	62	110	65	107	168	316	2600	2
M3.0013	81113	65	90	18	7.5	5.25	1.5	1.5	67	90	67	87	80	114	2900	1
M3.0113	81213	65	100	27	11	8	1.5	1.5	67	100	67	96	135	198	2700	1
M3.0213	89313	65	115	30	9	10.5	2	2	67	115	67	113	182	340	2500	2
M3.0014	81114	70	95	18	7.5	8.25	1.5	1.5	72	95	72	92	85	130	2800	1
M3.0114	81214	70	105	27	11	8	1.5	1.5	72	105	73	102	140	206	2650	1
M3.0214	89314	70	125	34	10	12	1	1	72	125	73	123	190	353	2350	2
M3.0015	81115	75	100	19	7.5	5.75	1.5	1.5	77	100	78	97	88	138	2600	1
M3.0115	81215	75	110	27	11	8	1.5	1.5	77	110	79	107	144	216	2500	1
M3.0215	89315	75	135	36	11	12.5	2.5	2.5	77	135	79	132	210	410	2250	2
M3.0016	81116	80	105	19	7.5	5.75	1.5	1.5	82	105	83	102	91	140	2500	1
M3.0116	81216	80	115	28	11	8.5	1.5	1.5	82	115	83	112	148	226	2400	1
M3.0216	89316	80	140	36	11	12.5	2.5	2.5	82	140	83	137	229	438	2100	2
M3.0017	81117	85	110	19	7.5	5.75	1.5	1.5	87	110	87	108	92	144	2400	1
M3.0117	81217	85	125	31	12	9.5	1.5	1.5	87	125	90	121	162	236	2250	1
M3.0217	89317	85	150	39	12	13.5	2.5	2.5	87	150	90	148	240	460	2050	2
M3.0018	81118	90	120	22	9	6.5	1.5	1.5	92	120	93	117	106	184	2300	1
M3.0118	81218	90	135	35	14	10.5	2	2	93	135	95	130	198	310	2000	1
M3.0218	89318	90	155	39	22	13.5	2.5	2.5	93	155	95	150	286	550	1800	2

C	Dynamic Load
Co	Static Load

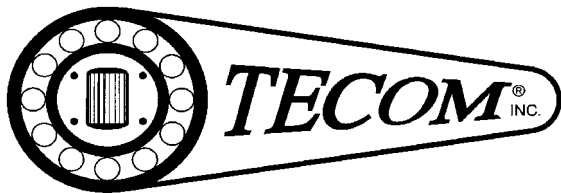

# ROLLER THRUST BEARINGS METRIC SIZES

Inside Diameters  
100mm to 240mm

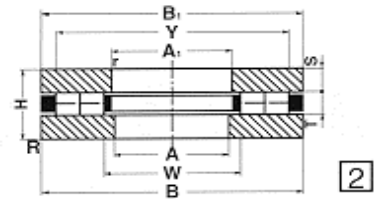
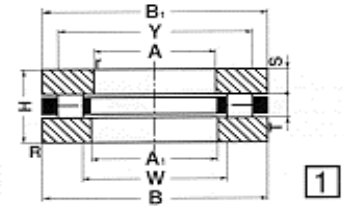

Part Number		A	B	H	T	S	R	r	A1	B1	W	Y	C	Co	RPM	Type
		mm	mm	mm	mm	mm	mm	mm	mm	mm	mm	mm	mm	KN		
M3.0020	81120	100	135	25	11	7	1.5	1.5	102	135	104	131	152	280	1900	1
M3.0120	81220	100	150	38	15	11.5	2	2	103	150	105	145	238	385	1700	1
M3.0220	89320	100	170	42	13	14.5	2.5	2.5	103	170	106	165	340	720	1550	2
M3.0022	81122	110	145	25	11	7	1.5	1.5	112	145	114	141	164	305	1800	1
M3.0122	81222	110	160	38	15	11.5	2	2	113	160	116	155	244	410	1660	1
M3.0222	89322	110	190	48	15	16.5	3	3	113	190	117	185	411	825	1400	2
M3.0024	81124	120	155	25	11	7	1.5	1.5	122	155	124	151	166	310	1600	1
M3.0124	81224	120	170	39	15	12	2	2	123	170	125	164	250	440	1400	1
M3.0224	89324	120	210	54	17	18.5	3.5	3.5	123	210	129	206	510	920	1200	2
M3.0026	81126	130	170	30	12	9	1.5	1.5	132	170	135	165	185	340	1400	1
M3.0126	81226	130	190	45	19	13	2.5	2.5	133	190	136	180	390	640	1200	1
M3.0226	89326	130	225	58	18	20	3.5	3.5	134	225	139	220	560	1320	1000	2
M3.0028	81128	140	180	31	12	9.5	1.5	1.5	142	180	145	175	198	395	1200	1
M3.0128	81228	140	200	46	19	13.5	2.5	2.5	143	200	147	192	397	660	1000	1
M3.0228	89328	140	240	60	19	20.5	3.5	3.5	144	240	152	235	670	1410	800	2
M3.0030	81130	150	190	31	12	9.5	1.5	1.5	152	190	155	185	210	440	1100	1
M3.0130	81230	150	215	50	21	14.5	2.5	2.5	153	215	158	210	480	820	1000	1
M3.0230	89330	150	250	60	19	20.5	3.5	3.5	154	250	162	245	730	1550	800	2
M3.0032	81132	160	200	31	12	9.5	1.5	1.5	162	200	165	195	220	490	950	1
M3.0132	81232	160	225	51	21	15	2.5	2.5	163	225	168	220	520	900	800	1
M3.0232	89332	160	270	67	21	23	4	4	164	270	170	265	760	1950	700	2
M3.0034	81134	170	215	34	14	10	2	1.5	172	215	176	209	300	580	850	1
M3.0134	81234	170	240	55	22	16.5	2.5	2.5	173	240	179	235	540	1050	750	1
M3.0234	89334	170	280	67	21	23	4	4	174	280	180	275	830	2300	650	2
M3.0036	81136	180	225	34	14	10	2	2	183	225	186	220	310	610	780	1
M3.0136	81236	180	250	56	22	17	2.5	2.5	183	250	187	245	560	1080	700	1
M3.0236	89336	180	300	73	24	24.5	4	4	184	300	190	295	880	2420	600	2
M3.0038	81138	190	240	37	15	11	2	2	193	240	197	234	340	710	700	1
M3.0138	81238	190	270	62	26	18	3	3	194	270	200	265	680	1270	650	1
M3.0238	89338	190	320	78	26	26	5	5	195	320	200	315	1060	2900	550	2
M3.0040	81140	200	250	37	15	11	2	2	203	250	207	246	360	760	680	1
M3.0140	81240	200	280	62	26	18	3	3	204	280	210	275	740	1380	620	1
M3.0240	89340	200	340	85	28	28.5	5	5	205	340	215	335	1420	3520	500	2
M3.0044	81144	220	270	37	15	11	2	2	223	270	227	265	390	860	650	1
M3.0144	81244	220	300	63	26	18.5	3	3	224	300	230	295	760	1460	600	1
M3.0344	89344	220	420	122			8	8	225	420	230	413	1680	3900	450	2
M3.0048	81148	240	300	45	18	13.5	2.5	2.5	243	300	248	296	510	1160	600	1
M3.0148	81248	240	340	48	32	23	3.5	3.5	244	340	255	335	1100	2050	550	1
M3.0348	89448	240	440	122			8	8	245	440	265	430	2320	440	400	2

C	Dynamic Load
Co	Static Load

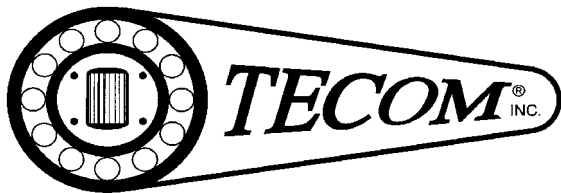

# ROLLER THRUST BEARINGS

## METRIC SIZES

Inside Diameters  
260mm to 400mm

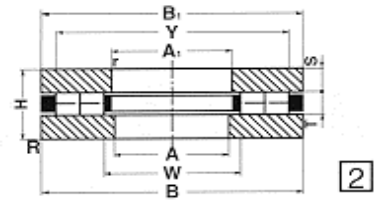
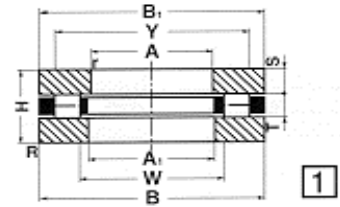

Part Number		A	B	H	T	S	R	r	A1	B1	W	Y	C	Co	RPM	Type
		mm	mm	mm	mm	mm	mm	mm	mm	mm	mm	mm	mm	KN		
M3.0052	81152	260	320	45	18	13.5	2.5	2.5	263	320	268	316	560	1240	550	1
M3.0152	81252	260	360	79	32	23.5	3.5	3.5	264	360	279	355	1200	2200	520	1
M3.0352	89452	260	480	132			8	8	265	480	284	472	2800	5600	380	2
M3.0056	81156	280	350	53	22	15.5	2.5	2.5	283	350	288	345	720	1700	500	1
M3.0156	81256	280	380	80	32	24	3.5	3.5	284	380	300	373	1280	2280	480	1
M3.0356	89456	280	520	145			8	8	285	520	305	513	2980	6100	350	2
M3.0060	81160	300	380	62	25	18.5	3	3	304	380	328	373	860	1810	470	1
M3.0160	81260	300	420	95	38	28.5	4	4	304	420	328	414	1400	2600	420	1
M3.0360	89460	300	540	145			8	8	305	540	332	530	3160	6900	330	2
M3.0064	81164	320	400	63	25	19	3	3	324	400	334	392	940	1960	420	1
M3.0164	81264	320	440	95	38	28.5	4	4	325	440	345	432	1820	3000	380	1
M3.0068	81168	340	420	64	25	19.5	3	3	344	420	354	415	1060	2180	400	1
M3.0168	81268	340	460	96	38	29	4	4	345	460	360	450	1980	3200	350	1
M3.0072	81172	360	440	65	25	20	3	3	364	440	374	430	1050	2200	400	1
M3.0172	81272	360	500	110	45	32.5	5	5	365	500	384	490	2040	3400	350	1
M3.0076	81176	380	460	65	25	20	3	3	384	460	392	452	1100	2450	350	1
M3.0176	81276	380	520	112	45	33.5	5	5	385	520	402	508	2400	4600	320	1
M3.0080	81180	400	480	65	25	20	3	3	404	480	412	470	1200	2400	340	1
M3.0180	81280	400	540	112	45	33.5	5	5	405	540	417	530	2500	4900	290	1

C	Dynamic Load
Co	Static Load